

MicroTron

Series A

Chemical Metering Pump

Menu Driven Flexibility

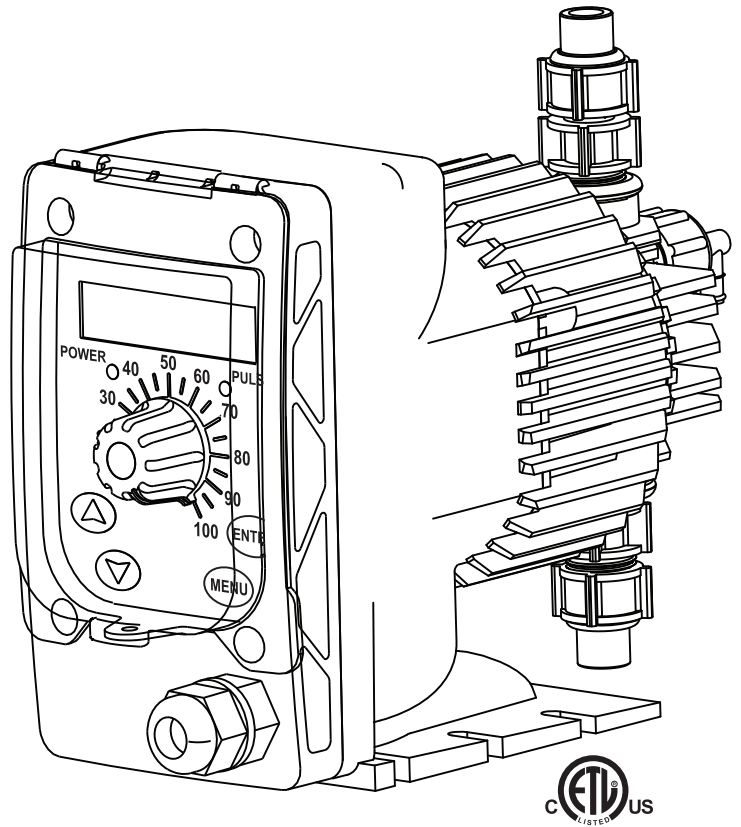

Key Features

- Dual Output Adjustment
- NEMA 4X Style Enclosure
- LED Backlit Display
- Optional Control Functions
- LED Indicating Lights
- Guided Double Ball Checks
- Priming / Degassing Valve
- Splash Cover Over Controls
- 2 Year Warranty

Application

MicroTron Series A metering pumps provide reliable, flexible chemical addition for a wide variety of applications.

Metering accuracy is achieved with microprocessor controlled menu adjustable speed and double ball guided checks. A rugged thermoplastic NEMA 4X style housing allows for outdoor installations.

Series A pumps are available in outputs up to 45 GPD and 250 PSI. The manual stroke length and menu speed adjustment provides the widest turn down capability.

Build a Model

Model A _____ - _____

Build your model number by selecting one code from each step. Example: A130X1-KVC1

STEP 1OUTPUT (MAXIMUM)

- 115 = 15 GPD / 2.37 LPH at 150 PSI (10.3 bar)
- 130 = 30 GPD / 4.70 LPH at 110 PSI (7.5 bar)
- 145 = 45 GPD / 7.09 LPH at 75 PSI (5.1 bar)
- 217 = 17 GPD / 2.60 LPH at 250 PSI (17.2 bar)

STEP 2CONTROL OPTIONS

- X = Standard
- M = 4-20 mA Input to control stroke speed
- T = Selectable Timer:
Pulse, Recycle, 28-Day, Multiply/Divide Pulses

STEP 3VOLTAGE

- 1 = 120 Volt USA Plug
- 2 = 240 Volt
- 3 = 240 Volt Specified Plug

STEP 4HEAD MATERIAL

- K = Kynar
- S = Stainless

STEP 5SEAT MATERIAL

- V = Viton
- F = Teflon
- H = Hypalon

STEP 6CHECK BALL

- C = Ceramic
- S = Stainless

STEP 7CONNECTIONS

- 1 = 3/8" (9.525 mm) Tubing - 110 & 150 psi
- 2 = 1/4" (6.35 mm) Tubing - 250 psi
- 3 = 3/8" (9.525 mm) Tubing - 250 psi
- P = 1/4" (6.35 mm) MNPT Connections
- V = 3/8" (9.525 mm) Vinyl Suction Tubing - 110 or 250 psi

For other options, see Price List or consult factory.

Accessories

Standard models include everything needed for immediate start-up: injection, foot and priming valve assemblies plus suction and discharge tubing.

Specifications

Electrical

- Input: 120 VAC or 240 VAC @ 50/60 Hz

Operational

- Stroke length adjustment - 10-100%
- Stroke frequency - Can be set from 1-125 strokes/minute or 1-125 strokes/hour on 15, 30 & 17 GPD models and 1-145 on 45 GPD.

Optional Timers

- Pulse: 0-59 min, 0-59 sec w/accumulator
- Recycle: 0-99 mm:ss on & 0-99 hh:mm off
- Biocide: 28 Day

Enclosure

Heavy duty NEMA 4X style high impact thermoplastic with clear lexan cover.

Environment

- Ambient temperature: 32° to 140°F (0°C to 60°C)
- Relative humidity: 0 to 100%

Shipping Weight: Approximately 10 lbs. (4.536 kg)

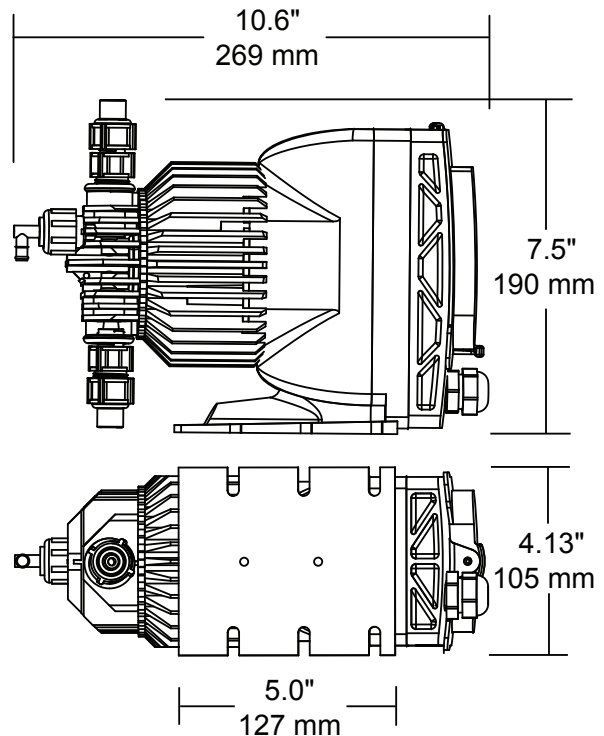

Get the Advantage



4700 Harold Abitz Dr
Muskogee, OK 74403
800-743-7431 phone
888-686-6212 fax
www.advantagecontrols.com