

February 2010



Installation & Instruction Manual for PCS-3000 Proofer Control System

W. H. Cooke & Co., Inc.
6868 York Rd.
Hanover, PA 17331

717-630-2222

www.whcooke.com

In 1986 the first Cooke Proofer Control System was built at the request of a well known bakery in Baltimore, Maryland. Over the years, improvements have made the system even more user friendly and flexible, but the basic concept of eliminating the problems associated with the wet/dry bulb method of measuring humidity in a proof box is still at the heart of our system.

The PCS-3000 control system uses plug in, state of the art, solid state components to make it the most accurate, trouble free proof box control system available anywhere.

Our V-2001-ST solid state sensor is actually two sensors in one housing. Thin film capacitance and resistance sensors measure humidity and temperature and are protected from flour dust and physical damage by a porous Teflon filter cap. The protective cap allows air in but keeps harmful elements out. The sensor is extremely responsive which you will see in just a few minutes. Upon initial installation of the sensor into your proof box, you may experience high humidity readings due to the sudden, drastic change in ambient relative humidity. The sensor may take 20 minutes in the high humidity environment for the reading to stabilize at the actual proof box humidity. The sensors are specially oriented to operate in a vertical plane. Please take special note of this and be sure to install the sensor as described in the installation instructions for best results.

Our controllers were selected and modified with software options so that operators quickly become comfortable with the system and so that the program cannot be modified unless you want to do so. The only setting the operator can change is the set point - and only if you want them to change it!

All components plug in and are housed in a Nema 4X enclosure with a see through door to keep flour dust and water out. The PCS-3000 system was specifically designed to control the environment in proof boxes and fermentation rooms and can be easily field modified to interface to your existing equipment. The panel is pre-wired to control either solenoid valves or proportional valves that are pneumatic or motor driven. Your system is already set up to operate per your instructions to us at the time of order, but it can be field changed at any time. Call us for details if the need ever arises.

High and low alarms operate lamps on the front panel and provide 115 VAC power to the alarm terminals on each instrument for use in remote alarming or operating air conditioning in a fermentation room application. During hot summer months some customers use the high temperature alarm to "dump" or exhaust excess hot air in the proof box.

The low alarm of the temperature controller is also wired through a "humidity lock out relay" to prevent steam from being introduced until the temperature inside the proof box is within 15 °F of the set point. For example, with a temperature set point of 115 °F, the humidity controller will not begin to operate (introduce wet steam) until the temperature inside the box is up to 100°F. This prevents condensation from forming inside the proof box.

Should you have the need to record the temperature and humidity inside the proof box, the system is pre-wired to provide dual 4 to 20 milliamp outputs to a remote device such as a recorder or PLC. Cooke Co. offers a two pen circular chart recorder and dual scale charts for this purpose. Request price and delivery on our model 7100 recorder. The controllers are also equipped with RS-485 communications with Modbus protocol for remote monitoring and control.

We've designed the PCS-3000 Proofer Control System after having interviewed Bakery Owners, Engineers and Production Supervisors around the country. We've listened carefully and believe this system fulfills the need for an accurate, reliable system that is easily retrofitted to your existing proof box. We think you'll agree.

Please read the following installation and operating instruction pages carefully. Call us if you have any questions.

Mounting / Installation of V-2001-ST Sensor:

Drill a 1/2" round hole through the side of the return duct (never the bottom) or through the wall of the proof box itself and slide the sensor tube through the opening. Use the two sheet metal screws provided to attach the V-2001-ST sensor to the side of the duct through the 2 holes in the outside of the square terminal head.

Always install the sensor horizontally and always mount the unit so that the cable connection is facing downwards towards the floor. The sensors inside of the protective Teflon cap are specially oriented to operate in this position.

When installing the sensor in the duct work, placement of the sensor should be well downstream from the point of entry of the return air. It is sometimes necessary to move the sensor around until the best location is found. For instance, if installing the sensor through the side wall of a walk-in proof box, do not mount the sensor near the door where an inrush of plant air will cause the readings to change rapidly. The sensor responds quickly to changes in the air and will cause the controllers to take corrective action.

Plug the cable connector into the sensor/transmitter connector and screw together until snug.

Important Note: Never expose the square sensor head assembly on the end of the sensor tube to excessive heat or humidity as this portion of the assembly is not designed to be installed inside the duct of the proof box. Install the tube as far inside the duct or box as practical with a minimum insertion of 5 inches.

Wiring of Sensor Cable:

The standard sensor cable for the Cooke PCS-3000 proofer system is 20 ft long (other lengths available upon request) with (3) stripped leads (red, black and white) at one end and a quick disconnect connector on the other end for connecting to our V-2001-ST temperature / humidity sensor. The (3) stripped / color coded leads should be connected to the proofer terminal strip as follows-----

Red Wire to Yellow terminal block labeled R/33 on far left side of the terminal strip
Black Wire to Yellow terminal block labeled B/35 on far left side of the terminal strip
White Wire to Yellow terminal block labeled W/30 on far left side of the terminal strip

Wiring of Outputs:

The Cooke PCS-3000 can control solenoid, pneumatic, or motor actuated valves depending on the model ordered. Please follow the instructions below for wiring the outputs of this system and refer to the wiring diagram on page 7 of this manual.

Relay Output for solenoid valve control – PCS-3000-R system

For Heat: Wire the (2) leads from the 110 VAC coil of your solenoid valve to White terminal #2 and Red terminal #17 of the terminal strip

For Humidity: Wire the (2) leads from the 110 VAC coil of your solenoid valve to White terminal #2 and Red terminal #27 of the terminal strip

Important Note: AC coils on solenoid valves and contactors can arc when opening and closing. To prevent this arcing from feeding back to the instruments and causing damage, you must install the (2) R/C snubbers (noise suppressors) across the AC coil of the respective solenoid valves, not across the output terminals of the controllers. See page 20 of this manual.

Milliamp Output for pneumatic or motor actuated valves – PCS-3000-MA system

Important Note: If you are changing our proofer system from controlling solenoid valves to motor actuated or pneumatic valves, your temperature and humidity controllers must be equipped with a 4-20 mA output to control pneumatic or motor actuated valves. Please make sure Model 3002-F-MA (4B-53) for temperature and Model 3002-RH-MA (4B-53) are installed in our panel to avoid damage to your equipment.

For Heat: Remove the jumper on terminal blocks #15 and #1. Remove the jumper on terminal blocks #17 and #19. Add a jumper to terminal blocks #5 and #19. Terminate your (2) control wires from your actuator or I to P transducer to terminal blocks 15(+) and 16(-)

For Humidity: Remove the jumper on terminal blocks #25 and #1. Remove the jumper on terminal blocks #27 and #29. Add a jumper to terminal blocks #6 and #29. Terminate your (2) control wires from your actuator or I to P transducer to terminal blocks 25(+) and 26(-)

- **Note: If you ordered the PCS-3000-MA milliamp output system, the jumpers have already been set as stated above.**

Connecting a Recorder or PLC to the PCS-3000 system

The Model 7100 2-pen circular chart recorder is shipped pre-programmed to accept the 4-20 mA retransmission signals from the PCS-3000 proofer control system. All configuration jumpers on the recorder's motherboard are properly set and (1) 250 ohm precision resistor is installed on each input channel of the recorder. The resistors must remain installed on the input terminals of the recorder to accurately convert the analog signal from the PCS-3000 system. Refer to the instructions and wiring diagram below for wiring the retransmission outputs.

An Installation and Operation manual is supplied with the recorder and is marked with the programming parameters entered in the recorder. Channel / Pen 1 is scaled for TEMPERATURE and uses the RED marking pen. Channel / Pen 2 is scaled for HUMIDITY and uses the GREEN marking pen. Either input channel on the recorder can be used to record temperature or humidity. The only programming difference in the two channels is the scaling (0-160F for temperature, 0-100% for humidity). Please refer to the recorder's manual for any additional programming information and installation instructions.

Note: In some instances, you may find the recorder displays a slightly different temperature or humidity than what the respective PCS-3000 controller displays. To have both instruments display the same value, it is recommended that an input correction (iCor) be entered into the recorder, not the PCS-3000. Refer to the recorder's manual for instructions to access this input correction (iCor) programming parameter.

To connect the model 7100 recorder:

1. Remove the jumpers from the blue terminals marked C1+ and C1- and C2+ and C2- in the main control panel.
2. Using a twisted shielded pair of 18-22 gauge instrument wire, connect the pair between C1+ and C1- on the terminal strip and terminals TB4 (1+) and TB4 (2-). See figure 2-4 on page 13 and figure 2-8 on page 15 of the recorder manual for wiring instructions. Be sure to observe polarity or recorder will not read the proper temperature. This connection is for the temperature side and works with the red pen.
3. Using a twisted shielded pair of 18-22 gauge instrument wire, connect the pair between C2+ and C2- on the terminal strip and terminals TB5 (1+) and TB5 (2-). See figure 2-4 on page 13 and figure 2-8 on page 15 of the recorder manual for wiring instructions. Be sure to observe polarity or recorder will not read proper humidity. This connection is for the humidity side and works with the green pen.

4. Connect a 120 VAC power source to terminals TB1 located in top right corner of recorder's back panel and ground the recorder. See figure 2-5 on page 14 of the recorder manual for proper connections.



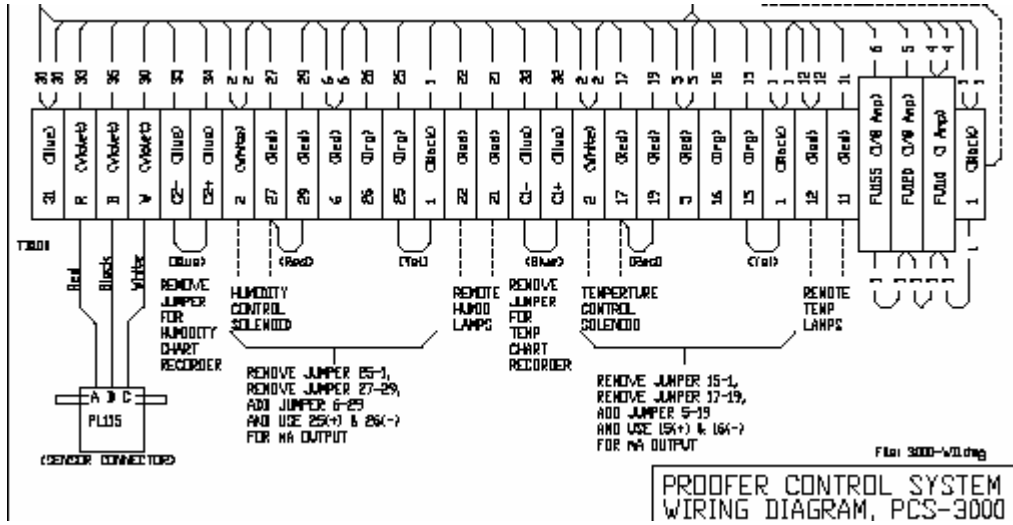

PCS-3000 Terminal Strip Diagram





Programming of Controllers:

Unlocking / Locking Programming Parameters:

The Cooke PCS-3000 proofer control system is shipped with both the temperature and relative humidity controllers programmed with programming parameters locked except for Setpoint Adjustment to avoid unwanted changes in critical programming parameters. If you should need to access all programming parameters, please follow these steps-----

1. To unlock programming, simultaneously press the  and 
2. After programming changes are made, it is recommended you lock the controller in . To do so, press the  key until LoC appears on the top display.

Using the  key, scroll until the bottom display reads  and press the  key to store the programming change. All programming parameters will be locked EXCEPT for setpoint adjustment.

Modes of Operation:



The temperature and humidity controllers have three modes of operation, REGULATION MODE, OPERATION MODE, AND INITIAL SETTING MODE. Follow the instructions below for accessing these modes:

Press the  key to access the REGULATION MODE

Press the  key to access the OPERATION MODE

Press the  key for 3 seconds to access the INTIAL SETTING MODE

Changing Setpoint Value:



To change the operating setpoint value, simply press the  or  keys until the bottom display value reads the value you wish to control your process. The bottom display will flash while being changed. To store the value, press the  key and the display will stop flashing.

Entering an Input Correction Valve:

If you should find the temperature and humidity readings are not accurate on the controllers, you have the ability to enter an input correction value into both the temperature and humidity controllers to correct the readings. The V-1001-ST and V-2001-ST temperature / RH sensors are equipped with an RTD sensor for measuring temperature. RTD sensors are extremely accurate and very rarely should an input correction be required for the temperature controller. The V-1001-ST and V-2001-ST sensors measure relative humidity to an accuracy of +/- 2%RH. If you should need to correct the process reading on the temperature or humidity controller, follow the instructions below. Note: You may need to unlock the controller before an input correction value can be entered. Refer to the unlocking and locking programming parameters on the previous page prior to attempting to enter an input correction value.





Press the  key to access the REGULATION MODE

Press the  key until  is displayed on the top display

Press the  or  keys until the bottom display reads the correction value you require and press the  key to store this value

Press the  key again to return to the HOME display

The following pages show the programming parameters and the parameter settings when shipped. Please take note that programming parameters are different not only for the temperature and humidity controllers, but for what type of outputs (relay or milliamp) are supplied. Below is an index of key operations and functions.

PV	displays process value
SV	displays setpoint value.
	INDEX: advances the display to the next menu item.
	UP ARROW: Increments a value or changes a menu item.
	DOWN ARROW: Increments a value or changes a menu item.
	ENTER: stores the value or item change.

PCS-3001-F-R TEMPERATURE CONTROLLER – RELAY OUTPUT (SOLENOID)

Regulation Mode: Press the  key to access the REGULATION MODE

HES Heating hysteresis setting
(Set in ON/OFF control mode)

Setting = 1.0

EPof Regulate temperature deviation value

Setting = 0.0

Operation Mode: Press the  key to access the OPERATION MODE

r-S Control setting RUN or STOP

Setting = rUn

SP Decimal point position selection
(except for B, S, R type, all the other types can be set)

Setting = 1

AL 1L Lower-limit alarm 1

Setting = 15.0

AL 2H Upper-limit alarm 2

Setting = 2.0

LoC Setting lock mode

Setting = LoC2

Initial Setting Mode: Press the  key for 3 seconds to access the INITIAL SETTING MODE

LoPt Set input type

Setting = rH4

EP-H Set upper-limit of temperature range

Setting = 160.0

EP-L Set lower-limit of temperature range

Setting = 0.0

PCS-3001-F-R TEMPERATURE CONTROLLER – RELAY OUTPUT
(SOLENOID) (CONTINUED)

Ctrl	Sets Control Mode: on/off, pid, Prog, or manual. (Set to ProG for ramp/soak patterns) See Pattern and set editing.	Setting = onof
S-HC	Select heating/cooling control or dual loop output control	Setting = HEAt
ALR1	Alarm 1 mode setting	Setting = 3
ALR2	Alarm 2 mode setting	Setting = 2
ALR3	Alarm 3 mode setting	Setting = 0
SALA	Set system alarm	Setting = oFF
CoSH	Communication write function enable/disable	Setting = oFF
E-5L	ASCII, RTU communication format selection	Setting = ASCII
E-no	Communication address setting	Setting = 1
bPS	Communication baud rate setting	Setting = 9600
LEn	Data length setting	Setting = 7
Prty	Parity bit setting	Setting = EuEn
Stop	Stop bit setting	Setting = 1

PCS-3001-RH-R HUMIDITY CONTROLLER – RELAY OUTPUT (SOLENOID)

Regulation Mode: Press the  key to access the REGULATION MODE

HES Heating hysteresis setting
(Set in ON/OFF control mode)

Setting = 1.0

EPof Regulate temperature deviation value

Setting = 0.0

Operation Mode: Press the  key to access the OPERATION MODE

r-S Control setting RUN or STOP

Setting = rUn

SP Decimal point position selection
(except for B, S, R type, all the other types can be set)

Setting = 1

RL 1L Lower-limit alarm 1

Setting = 2.0

RL 2H Upper-limit alarm 2

Setting = 2.0

LoC Setting lock mode

Setting = LoC2

Initial Setting Mode: Press the  key for 3 seconds to access the INITIAL SETTING MODE

LoPt Set input type

Setting = rH4

EP-H Set upper-limit of temperature range

Setting = 100

EP-L Set lower-limit of temperature range

Setting = 0

PCS-3001-RH-R HUMIDITY CONTROLLER – RELAY OUTPUT (SOLENOID)
(CONTINUED)

Ctrl	Sets Control Mode: on/off, pid, Prog, or manual. (Set to ProG for ramp/soak patterns) See Pattern and set editing.	Setting = onof
S-HC	Select heating/cooling control or dual loop output control	Setting = HEAt
ALR1	Alarm 1 mode setting	Setting = 3
ALR2	Alarm 2 mode setting	Setting = 2
ALR3	Alarm 3 mode setting	Setting = 0
SALA	Set system alarm	Setting = oFF
CoSH	Communication write function enable/disable	Setting = oFF
E-5L	ASCII, RTU communication format selection	Setting = ASCII
E-no	Communication address setting	Setting = 1
bPS	Communication baud rate setting	Setting = 9600
LEn	Data length setting	Setting = 7
Prty	Parity bit setting	Setting = EuEn
Stop	Stop bit setting	Setting = 1

PCS-3002-F-MA TEMPERATURE CONTROLLER – MA OUTPUT

Regulation Mode: Press the  key to access the REGULATION MODE

At Auto-tuning

(Set in PID control and RUN mode)

Setting = on

(Turn this setting on when the system is installed and outputs are wired to enable auto-tuning. The controller will automatically assign PID control parameters to properly actuate your proportional valves. The controller will automatically turn off auto-tuning when complete.)

PCdn 4 groups PID modes (n=0~3). When n=4, PID control is auto regulated.

Setting = PCd4 / Auto

tPof Regulate temperature deviation value

Setting = 0.0

[rH] Regulate upper-limit of analog output value

Setting = 0.0

[rLo] Regulate lower-limit of analog output value

Setting = 0

Operation Mode: Press the  key to access the OPERATION MODE

r-S Control setting RUN or STOP

Setting = rUn

SP Decimal point position selection (except for B, S, R type, all the other types can be set)

Setting = 1

AL 1L Lower-limit alarm 1

Setting = 2.0

AL 2H Upper-limit alarm 2

Setting = 2.0

LoC Setting lock mode

Setting = LoC2

out 1 Display and adjust output value of 1st output group

Setting = 100.0

PCS-3002-F-MA TEMPERATURE CONTROLLER – MA OUTPUT (CONTINUED)

Initial Setting Mode: Press the  key for 3 seconds to access the INITIAL SETTING MODE

INPT	Set input type	Setting = rH4
EP-H	Set upper-limit of temperature range	Setting = 160.0
EP-L	Set lower-limit of temperature range	Setting = 0.0
CTRL	Sets Control Mode: on/off, pid, Prog, or manual. (Set to ProG for ramp/soak patterns) See Pattern and set editing.	Setting = Pid / PCd
S-HC	Select heating/cooling control or dual loop output control	Setting = HEAt
AL1	Alarm 1 mode setting	Setting = 3
AL2	Alarm 2 mode setting	Setting = 2
AL3	Alarm 3 mode setting	Setting = 0
SALA	Set system alarm	Setting = oFF
CO5H	Communication write function enable/disable	Setting = oFF
E-5L	ASCII, RTU communication format selection	Setting = ASCII
E-no	Communication address setting	Setting = 1
bPS	Communication baud rate setting	Setting = 9600
LEN	Data length setting	Setting = 7
Prty	Parity bit setting	Setting = EuEn
Stop	Stop bit setting	Setting = 1

PCS-3002-RH-MA HUMIDITY CONTROLLER – MA OUTPUT

Regulation Mode: Press the  key to access the REGULATION MODE

At Auto-tuning

(Set in PID control and RUN mode)

Setting = on

(Turn this setting on when the system is installed and outputs are wired to enable auto-tuning. The controller will automatically assign PID control parameters to properly actuate your proportional valves. The controller will automatically turn off auto-tuning when complete.)

PCdn 4 groups PID modes (n=0~3). When n=4, PID control is auto regulated.

Setting = PCd4 / Auto

tPof Regulate temperature deviation value

Setting = 0.0

[rH] Regulate upper-limit of analog output value

Setting = 0.0

[rLo] Regulate lower-limit of analog output value

Setting = 0

Operation Mode: Press the  key to access the OPERATION MODE

r-S Control setting RUN or STOP

Setting = rUn

SP Decimal point position selection (except for B, S, R type, all the other types can be set)

Setting = 1

AL 1L Lower-limit alarm 1

Setting = 2.0

AL 2H Upper-limit alarm 2

Setting = 2.0

LoC Setting lock mode

Setting = LoC2

out 1 Display and adjust output value of 1st output group

Setting = 100.0

PCS-3002-RH-MA HUMIDITY CONTROLLER – MA OUTPUT (CONTINUED)

Initial Setting Mode: Press the  key for 3 seconds to access the INITIAL SETTING MODE

INPT	Set input type	Setting = rH4
UP-H	Set upper-limit of temperature range	Setting = 100.0
UP-L	Set lower-limit of temperature range	Setting = 0.0
CTRL	Sets Control Mode: on/off, pid, Prog, or manual. (Set to ProG for ramp/soak patterns) See Pattern and set editing.	Setting = Pid / PCd
S-HC	Select heating/cooling control or dual loop output control	Setting = HEAt
AL1	Alarm 1 mode setting	Setting = 3
AL2	Alarm 2 mode setting	Setting = 2
AL3	Alarm 3 mode setting	Setting = 0
SALA	Set system alarm	Setting = oFF
CO5H	Communication write function enable/disable	Setting = oFF
E-5L	ASCII, RTU communication format selection	Setting = ASCII
E-no	Communication address setting	Setting = 1
bPS	Communication baud rate setting	Setting = 9600
LEN	Data length setting	Setting = 7
Prty	Parity bit setting	Setting = EuEn
Stop	Stop bit setting	Setting = 1

Troubleshooting of Controllers:

Below are error messages and definitions that may appear on the controllers:

Sensor didn't connect			Input error	
PV	no	No	Err	Error
SV	Cont	Connect	Cont	Input
EEPROM error			Input over range	
PV	Err	Error	2001	PV flash when over
SV	Prn	EEPROM	00	

***The controllers will display a negative PV value if the temperature / humidity sensor has failed or is not wired properly. Try installing a new sensor to correct the problem. If this does not solve the problem, check the programming for each controller.**

List of spare parts (prices subject to change):

CAT# IP-500 - I to P (current to pneumatic) transducers for operating 3-15 psi Valve with the PCS-3000-MA control System	395.00
Cat# 1006-RC Snubber (order 1 additional snubber for each valve over 2)	20.00
Cat# V-1002-MS Sensor Cable (20 ft.) Adder per ft. of cable over 20 ft. 1.00	85.00
Model V-2001-ST sensor/transmitter	895.00
Model 3001-F-R (relay output) temp controller	295.00
Model 3001-RH-R (relay output) rH controller	295.00
Model 3002-F-MA (4-20 milliamp output) temp controller	295.00
Model 3002-RH-MA (4-20 milliamp output) rH controller	295.00

Contact us for information and prices on solenoid and pneumatic valves.

For other products available from W. H. Cooke & Co. see below and visit www.whcooke.com



Model 7000 - Two Pen circular chart recorder with one box of charts, one set of pens (1 red, 1 green), mounting brackets, and instruction manual.



Model RTS-800 Thermocouple Dough Temperature Monitoring System

With .1° F resolution digital LED temperature indicator featuring input correction & mounted in a 9" x 7" x 5" deep polycarbonate enclosure. Includes model RT-888 heavy duty temperature sensor .250" OD x 6" long with handle, 90° bend, 24" blue coiled cord (10ft when extended) secured with S.S. wire rope tether to control box.



Model KCB-EF-100 "Eternal Flame" - Nema 4X 304 s.s. heater termination/control box 6" x 6" x 4" deep with circuit breaker, current transformer for heater lead, LED through door indicator, keypad lock and 120 VAC line cord.

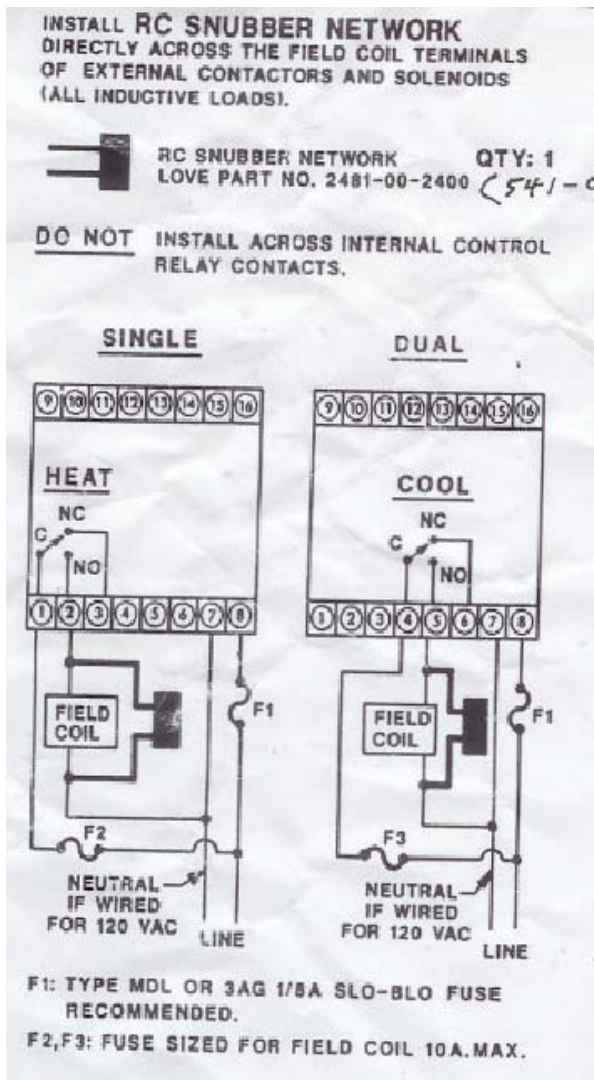

WHAT YOU SHOULD KNOW ABOUT ELECTRICAL NOISE AND MICROPROCESSOR BASED INSTRUMENTS

Microprocessor based instruments require a “clean” source of power that is steady and free of noise. Electrical noise may be caused by line faults, power switching, motors, motor controllers or power controllers containing SCR devices. Without a clean source, any microprocessor device is prone to failure.

Electrical noise can also be created by devices that are connected to a control’s output load circuit. A common source of electrical noise is the field coil of a contactor or solenoid. Where external contactors (mechanical or mercury) or solenoids are used in load circuits, large voltage spikes are generated when they are de-energized. These spikes cause arcing of the instrument relay contacts, putting the generated noise right near the microprocessor circuits.

If your power source is not from a clean line, your system can be protected by installing a power line spike and noise suppressor. We recommend the model #2851-1-120 shown on the back page of the brochure located in back of the instruction booklet.

Where external contactors or solenoids are used with relay output instruments, an R/C snubber network (part number 1006-RC) should be used. The snubber installs easily directly across the field coil terminals of the relay or solenoid. See instructions on reverse side. A snubber is shipped with each model 1005 and 1600 series instrument having a relay output.

I to P Transducer Installation / Calibration

1.1 Description

1.1.1 The ControlAir Type 500X converts a current or voltage input signal to a linearly proportional pneumatic output pressure. This versatile instrument is designed for control applications that require a high degree of reliability and repeatability at an economical cost.

1.2 Principle of Operation

1.2.1 The Type 500X is a force balance device in which a coil is suspended in the field of a magnet by a flexure. Current flowing through the coil generates axial movement of the coil and flexure. The flexure moves towards the nozzle and creates back pressure which acts as a pilot pressure to an integral booster relay. Input signal increases (or) decreases for reverse acting) cause proportional output pressure increases. Zero and Span are calibrated by turning adjust screws on the front face of the unit. Adjustment of the zero screw repositions the nozzle relative to the flexure. The span adjustment is a potentiometer that controls the amount of current through the coil.

1.3 Mounting

1.3.1 Unit may be pipe, panel, or bracket mounted. Mounting may be at any angle, though may require field adjustment. High external vibration may cause output fluctuations. Mounting in a vibration-free area is recommended.

1.4 Pneumatic Connections

1.4.1 The 1/4 NPT supply and output ports are marked "IN" and "OUT" respectively on the base of the unit. Clean all pipe lines to remove contamination before installation. Apply pipe compound to male threads of the air line only. Avoid getting compound in the air lines. Clean dry instrument quality air must be used. To insure optimum performance supply pressure should be regulated. To provide stable inlet pressure and prevent contamination of the internal section of the transducer the use of an Instrument Air Filter Regulator is recommended. The two unmarked ports on the base of the unit are gage ports but may be used as alternative output ports. Any unused ports must be plugged.

1.5 Electrical Connections

1.5.1 Electrical connections are made to the black and white leads extending out from the 1/2 NPT conduit fitting.

When the positive side of the input signal is connected to the black lead, the output pressure will increase as the input signal increases. For reverse acting mode (increasing input signal decreases output pressure), connect positive side of the input signal to the white lead.

Figure 1 DIN 43650 Connector

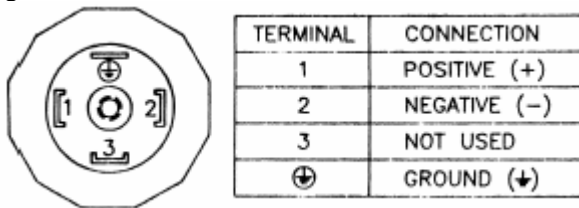

I to P Transducer Installation / Calibration (continued)

2.1 Calibration

2.1.1 Zero and Span should always be checked after mounting. If unit is calibrated in a vertical position and then mounted at an angle, readjustment of the zero is necessary. To calibrate use the following procedure:

1. Open protective covers to expose zero and span adjustment screws.
2. Connect the recommended air supply to the inlet of the transducer and an accurate pressure gage to the outlet.
3. Connect the electrical input and set the input signal to the minimum value of the range being used (e.g. 4 mA for a 4-20 mA unit).
4. Observe the output pressure. If necessary adjust zero screw until reaching minimum output pressure setting.

Turn zero screw counter clockwise to increase pressure, clockwise to decrease pressure.

If unable to achieve output during calibration process, turn zero adjustment screw counter clockwise for up to 30 revolutions, until output pressure rises.

5. Increase electrical input signal to its maximum value (e.g. 20 mA for a 4-20 mA unit).
6. Observe the output pressure. If necessary adjust the span screw until reaching maximum output pressure setting.

For I/P (current) input models turn span screw counter clockwise to increase pressure, clockwise to decrease pressure. For E/P (voltage) input models turn span screw clockwise to increase pressure, counter clockwise to decrease pressure.

7. The Zero and Span adjustments are interactive. After adjusting the span it will be necessary to recheck the zero. Repeat steps 3-6 until both end points are at the required values.

8. **For reverse acting** performance interchange the black and white electrical signal leads and carry out the same procedure as described above. Adjust the zero screw with minimum input (4mA) to get maximum output then adjust span screw with maximum input (20mA) to get minimum output. Repeat as necessary.