

THERMOCOUPLES & RTDS

BAYONET TYPE

For Use To 800°F.

WITH ADJUSTABLE LENGTH SPRING

Cuts inventory cost. Fits hole depths from 1" to 14".
 Bayonet cap turns to desired immersion length.
 Flexible. Bends to any angle.

Catalog Number	Termination Style
L08-1	1
L08-2	2
L08-3	3

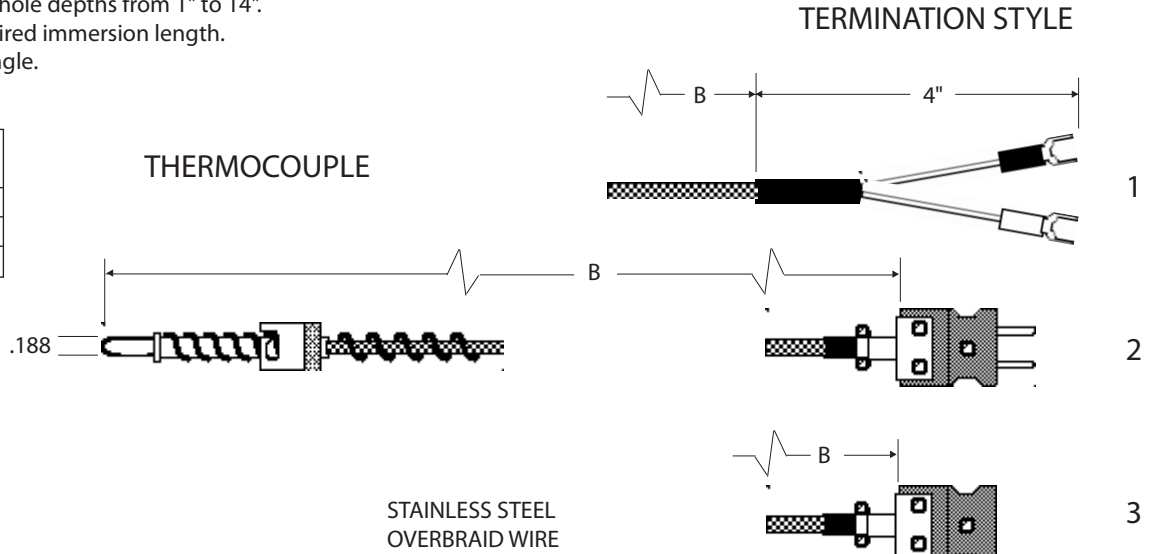

HOW TO ORDER:

1. Specify catalog number
2. Specify "B" length.
3. Specify "J" or "K" calibration
4. For dual element add suffix "D" to catalog number.

Order Example: L08-1-J B=4'

WITH ADJUSTABLE LENGTH FLEX HOSE

Same advantages as above but not as flexible.
 Bayonet cap turns over entire length.
 Not as much spring tension as spring type above.

Catalog Number	Termination Style
L08-14	1
L08-15	2
L08-16	3

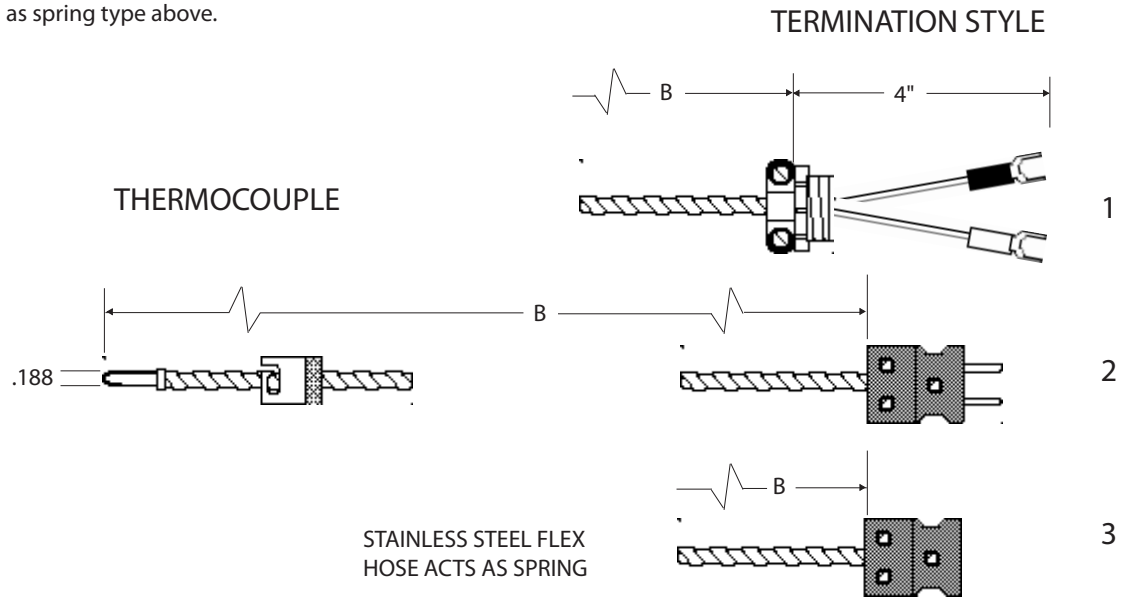

HOW TO ORDER:

1. Specify catalog number
2. Specify "B" length.
3. Specify "J" or "K" calibration.
4. For dual element add suffix "D" to catalog number.

NOTE: Construction: 304 S. S. flex hose and tubing, 20 gauge fiberglass insulated stranded wire. See page 8 for Bayonet Adaptors.

BAYONET TYPE

For Use To 800°F.

WITH FIXED LENGTH

Straight

Catalog Number	Termination Style
L08-4	1
L08-7	2
L08-10	3

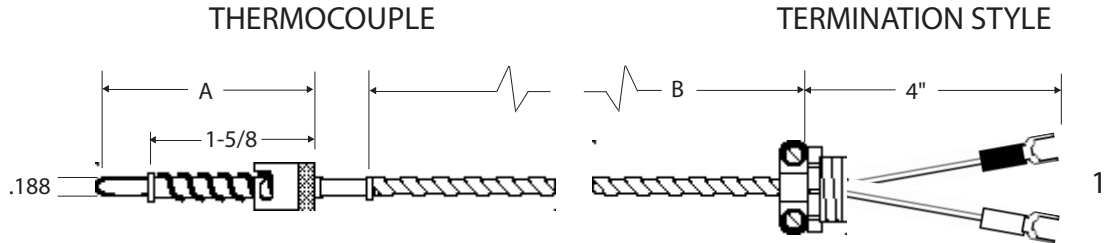

45° Bend

Catalog Number	Termination Style
L08-5	1
L08-8	2
L08-11	3

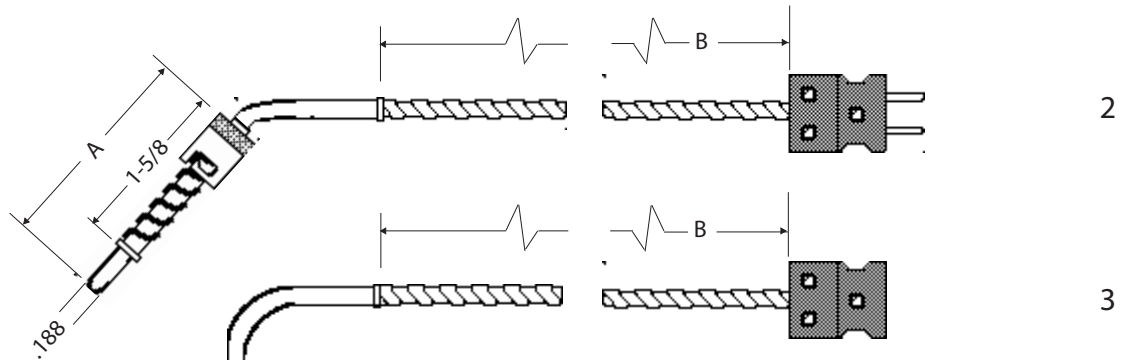

90° Bend

Catalog Number	Termination Style
L08-6	1
L08-9	2
L08-12	3

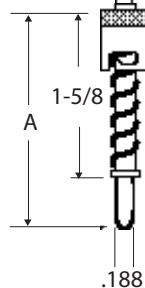

NOTE: Construction: 304 S. S. flex hose and tubing, spring, 20 gauge fiberglass insulated stranded wire. Adaptors are not furnished with thermocouples and must be ordered separately. See page 8.

HOW TO ORDER:

1. Specify catalog number.
 2. Specify "A" length.
 3. Specify "B" length.
 4. Specify "J" or "K" calibration.
 5. For dual element add suffix "D" to catalog number.
- Order Example: L08-9-J-D A=2" B=4"

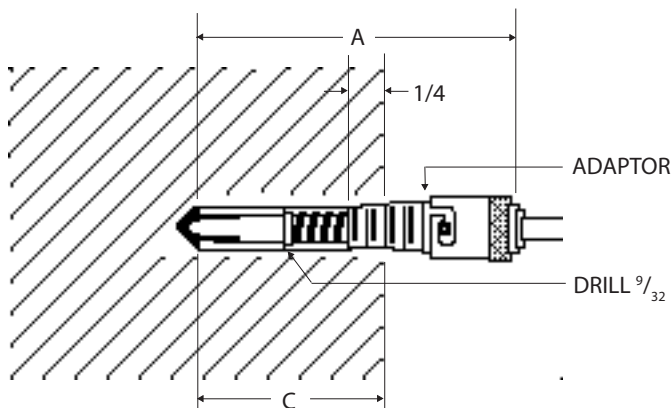

Selection of adaptor and hole depth "C" determines the required "A" dimension. See chart at right.

SELECTION TABLE FOR "A" DIMENSION OF FIXED LENGTH BAYONET TYPE THERMOCOUPLE

"C" Hole Depth In Inches	"A" Dimension Inches		
	7/8" Long Adaptor	1 3/8" Long Adaptor	2 1/2" Long Adaptor
1/4 to 1/2	1 5/8	2	3 1/8
1/2 to 1	2	2 1/2	3 5/8
1 to 1 1/2	2 1/2	3	4 1/8
1 1/2 to 2	3	3 1/2	4 5/8
2 to 2 1/2	3 1/2	4	5 1/8
2 1/2 to 3	4	4 1/2	5 5/8
3 to 3 1/2	4 1/2	5	6 1/8
3 1/2 to 4	5	5 1/2	6 5/8
4 to 4 1/2	5 1/2	6	7 1/8
4 1/2 to 5	6	6 1/2	7 5/8
5 to 5 1/2	6 1/2	7	8 1/8
5 1/2 to 6	7	7 1/2	8 5/8
6 to 6 1/2	7 1/2	8	9 1/8

ADJUSTABLE COMPRESSION FITTING

For Use To 800°F.

Straight

Catalog Number	Termination Style
L18-1	1
L18-4	2
L18-7	3

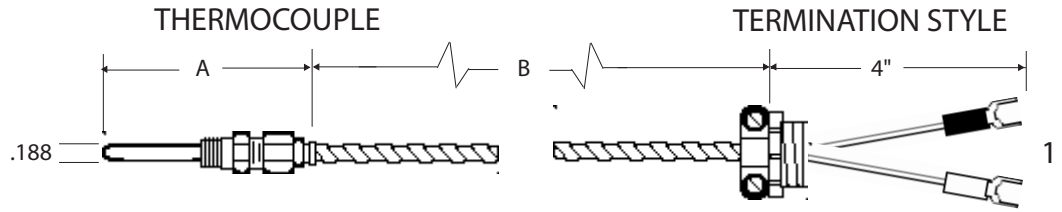

45° Bend

Catalog Number	Termination Style
L18-2	1
L18-5	2
L18-8	3

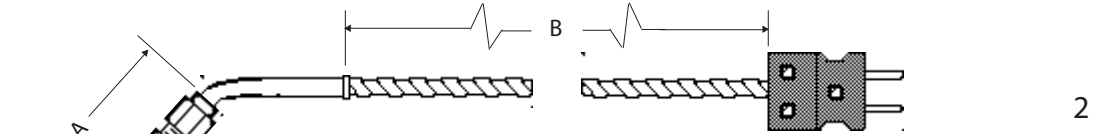

90° Bend

Catalog Number	Termination Style
L18-3	1
L18-6	2
L18-9	3

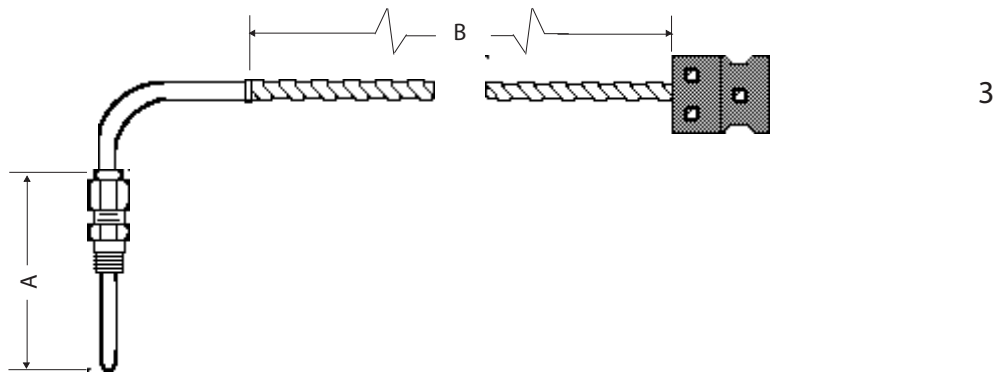

HOW TO ORDER:

1. Specify catalog number.
2. Specify "B" length.
3. Specify "J" or "K" calibration.
4. For dual element add suffix "D" to catalog number.

Order Example: L18-2-J-D B=4'

NOTE:

Construction: 304 S. S. hose and tubing, 20 gauge fiberglass insulated stranded wire. A brass compression fitting with 1/8" NPT is furnished with each thermocouple. See page 8 for S. S. fittings.

NOT-IN-MELT TYPE THERMOCOUPLE

Catalog Number	Termination Style
L48-1	1
L48-2	2
L48-3	3

HOW TO ORDER:

1. Specify catalog number.
 2. Specify "B" length.
 3. Specify "J" or "K" calibration.
- Order Example: L48-1-J B=4'

THERMOCOUPLE

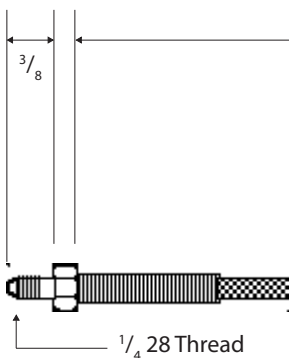

TERMINATION STYLE

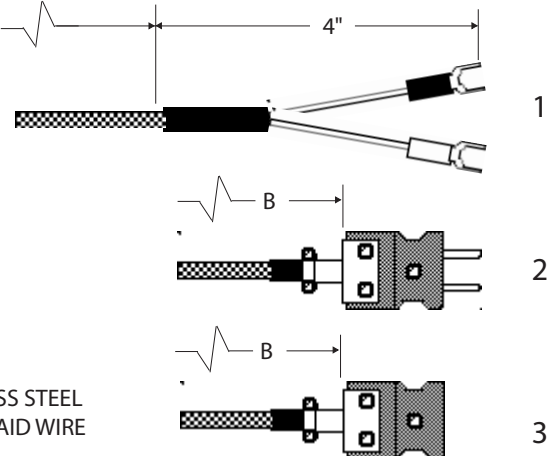

STAINLESS STEEL OVERBRAID WIRE

GENERAL PURPOSE THERMOCOUPLE For Use To 900° F.

Catalog Number	Type
L18-38	Iron-Constantan Max. Temp. 900°F.
L18-38-SS	Iron-Constantan Max. Temp. 900°F.

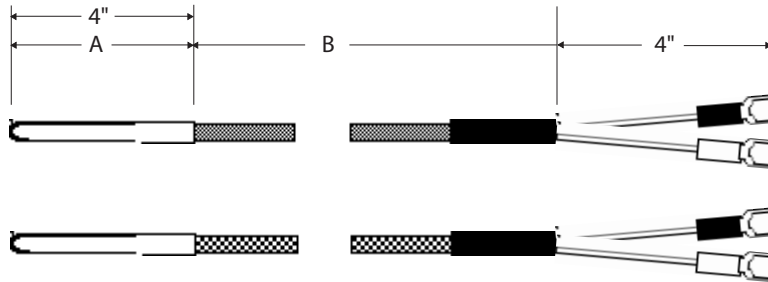

Stainless steel 3/16" O. D. tip with 20 ga. fiberglass covered wires.

Stainless steel 3/16" O. D. tip with 20 ga. F/G S. S. overbraided covered wires.

HOW TO ORDER:

1. Specify catalog number
2. Specify "A" length.
3. Specify "B" length.

Order Example: L18-38 A=4" B=5'

THERMOCOUPLE

TERMINATION STYLE

SURFACE THERMOCOUPLE For Use To 800° F.

Catalog Number		Termination
15/32 Dia.	7/32 For #10 Screw	
L58-1	L58-17	1
L58-2	L58-18	2
L58-3	L58-19	3

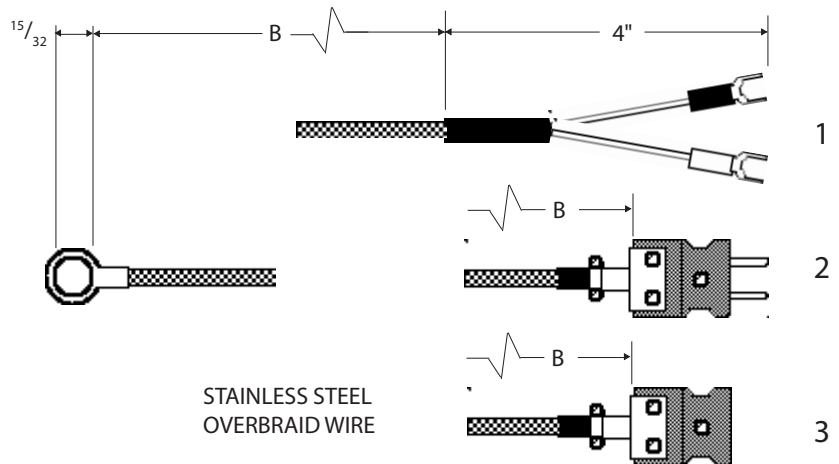

STAINLESS STEEL OVERBRAID WIRE

HOW TO ORDER:

1. Specify catalog number.
2. Specify "B" length.
3. Specify "J" or "K" calibration.

Order Example: L58-1-J B=4'

STICK-ON TYPE THERMOCOUPLE For Use To 400° F.

Catalog Number	Termination Style
L-PSA-1	1
L-PSA-2	2
L-PSA-3	3

THERMOCOUPLE

TERMINATION STYLE

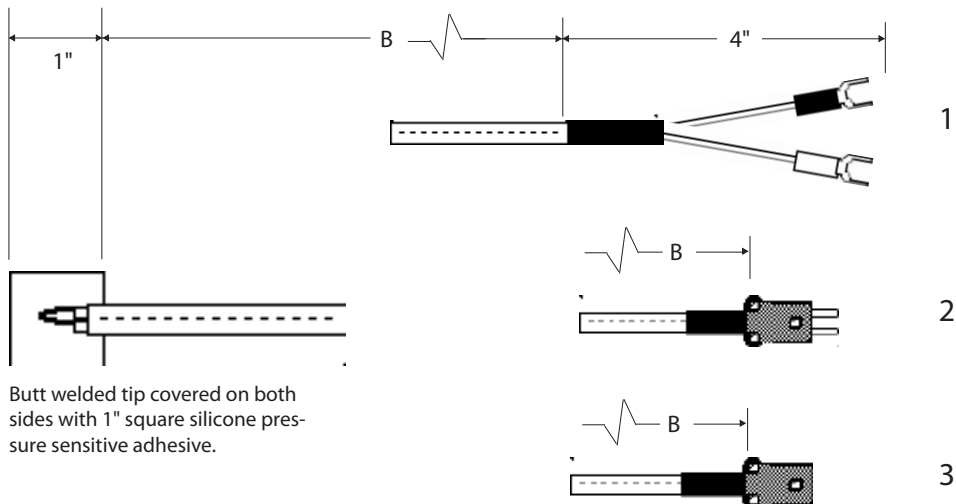

Butt welded tip covered on both sides with 1" square silicone pressure sensitive adhesive.

HOW TO ORDER:

1. Specify catalog number.
2. Specify "B" length.
3. Specify "J" or "K" calibration.

Order Example: L-PSA-1-J B=4'

NOTE: Available in Type "T" calibration by special order.
Connectors shown are "mini" style. Standard connectors available on request.

PLASTICS MELT EXTRUDER TYPE

For Use To 800°F.

WITH RIGID PLUG EXTENSION

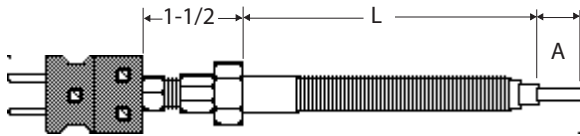

SINGLE ELEMENT

Catalog Number	"A"	"L"
L28-1	Flush	3"
L28-2	1/4"	3"
L28-3	1/2"	3"
L28-4	3/4"	3"
L28-5	1"	3"
L28-6	Flush	6"
L28-7	1/4"	6"
L28-8	1/2"	6"
L28-9	3/4"	6"
L28-10	1"	6"

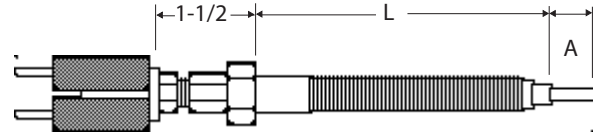

DUAL ELEMENT

Catalog Number	"A"	"L"
L28-11	Flush	3"
L28-12	1/4"	3"
L28-13	1/2"	3"
L28-14	3/4"	3"
L28-15	1"	3"
L28-16	Flush	6"
L28-17	1/4"	6"
L28-18	1/2"	6"
L28-19	3/4"	6"
L28-20	1"	6"

WITH FLEXIBLE HOSE TO PLUG EXTENSION

SINGLE ELEMENT

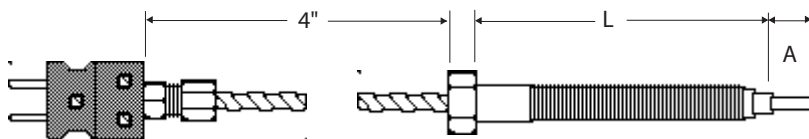

Catalog Number	"A"	"L"
L28-21	Flush	3"
L28-22	1/4"	3"
L28-23	1/2"	3"
L28-24	3/4"	3"
L28-25	1"	3"
L28-26	Flush	6"
L28-27	1/4"	6"
L28-28	1/2"	6"
L28-29	3/4"	6"
L28-30	1"	6"

DUAL ELEMENT

Catalog Number	"A"	"L"
L28-31	Flush	3"
L28-32	1/4"	3"
L28-33	1/2"	3"
L28-34	3/4"	3"
L28-35	1"	3"
L28-36	Flush	6"
L28-37	1/4"	6"
L28-38	1/2"	6"
L28-39	3/4"	6"
L28-40	1"	6"

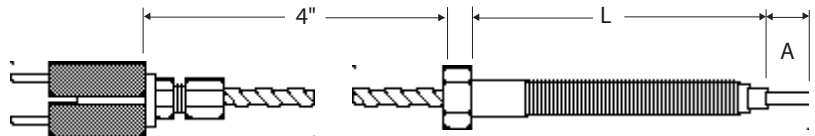

HOW TO ORDER:

Specify Catalog Number

NOTE: Calibration is Type J (Iron-Constantan). Type T (Copper-Constantan) and Type K (Chromel-Alumel) can be furnished on request. Construction: 304 S. S. flex hose and body. Single element made with 24 gauge fiberglass insulated wire. Dual element made with 30 gauge wire.

EXTENSION CABLE ASSEMBLIES

SINGLE ELEMENT

Catalog Number	Termination Styles	
L38-1	1	1

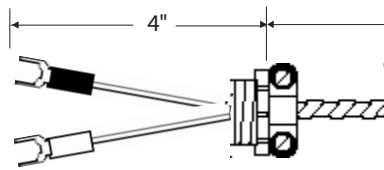

L38-2	2	1
L38-2M	2M	1

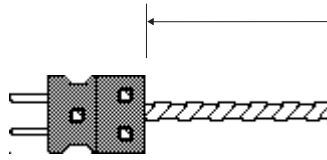

L38-3	3	1
L38-3M	3M	1

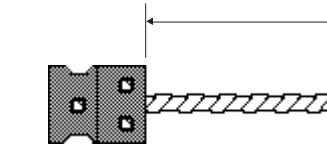

L38-7	2	3
L38-7M	2M	3M

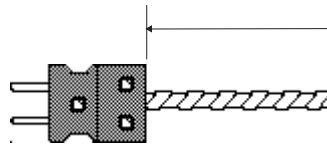

L38-8	2	2
L38-8M	2M	2M

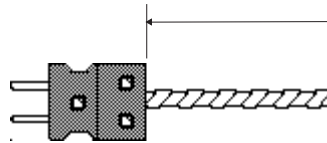

L38-9	3	3
L38-9M	3M	3M

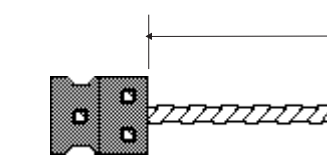

DUAL ELEMENT

Duals are available in all of the above configurations. When ordering add D as a suffix to the number. e.g. L38-2-D.

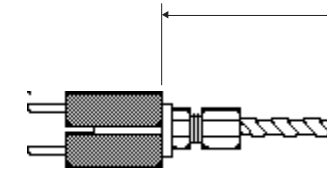

MINI PLUGS AND JACKS

Mini plugs and jacks are available in all of the above configurations. When ordering add M as a suffix to the number. e.g. L38-

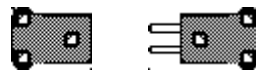

NOTE: Construction: Stainless steel, 3/16"ID S. S. hose tubing, 20 stranded gauge fiberglass insulated stranded wire.

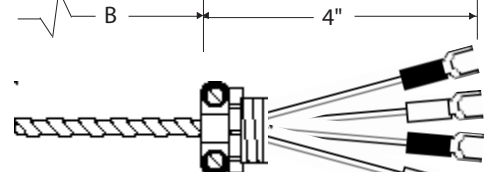
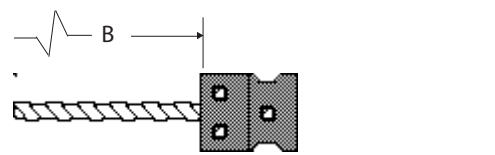
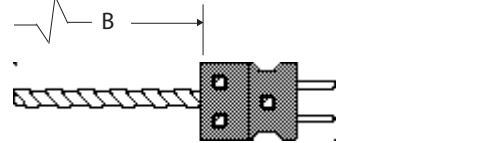
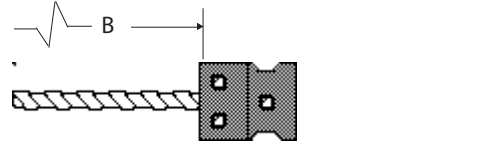
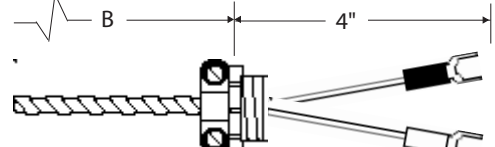
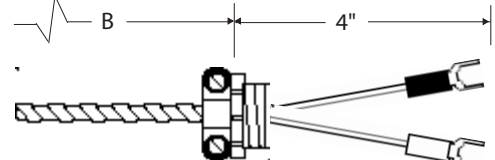
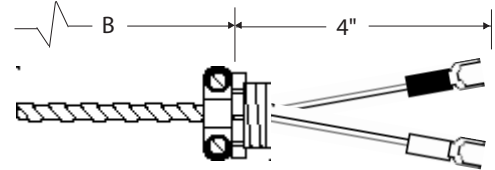

TERMINATION STYLE 1 :

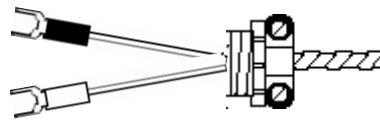

TERMINATION STYLE 2 :

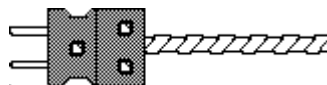

TERMINATION STYLE 3 :

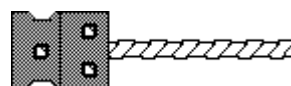

MINIATURE PLUGS AND JACKS



COLOR CODED FEMALE MINI JACKS

Catalog Number	Type	Color
MJ-J	Iron-Constantan (J)	Black
MJ-K	Chromel-Alumel (K)	Yellow
MJ-T	Copper-Constantan (T)	Blue
MJ-R/S	Platinum/ RHO 10% & 13% (R/S)	Green

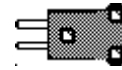

COLOR CODED MALE MINI PLUGS

Catalog Number	Type	Color
MP-J	Iron-Constantan (J)	Black
MP-K	Chromel-Alumel (K)	Yellow
MP-T	Copper-Constantan (T)	Blue
MP-R/S	Platinum/ RHO 10% & 13% (R/S)	Green

STANDARD PLUGS AND JACKS



COLOR CODED FEMALE STANDARD JACKS

Catalog Number	Type	Color
SJ-J	Iron-Constantan (J)	Black
SJ-K	Chromel-Alumel (K)	Yellow
SJ-T	Copper-Constantan (T)	Blue
SJ-R/S	Platinum/ RHO 10% & 13% (R/S)	Green

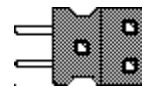

COLOR CODED MALE STANDARD PLUGS

Catalog Number	Type	Color
SP-J	Iron-Constantan (J)	Black
SP-K	Chromel-Alumel (K)	Yellow
SP-T	Copper-Constantan (T)	Blue
SP-R/S	Platinum/ RHO 10% & 13% (R/S)	Green

BAYONET ADAPTORS - NICKEL PLATED STEEL S. S. AVAILABLE UPON REQUEST

Catalog Number	Length	Thread
L68-1	7/8"	1/8 - 27 N.P.T.
L68-2	7/8"	3/8" - 24
L68-3	1-3/8"	1/8 - 27 N.P.T.
L68-4	1-3/8"	3/8" - 24
L68-5	2-1/2"	1/8 - 27 N.P.T.
L68-6	2-1/2"	3/8" - 24
L68-15	2-3/8"	14 x 1.5 MM
L68-16	2-1/2"	10 x 1.5 MM

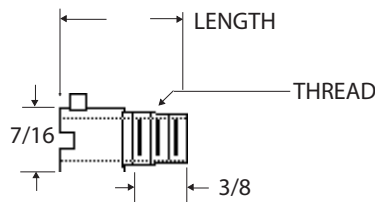

PANEL JACK

(One piece construction mounts in 1-1/8" cutout)



H32 Panel Jack (Specify J,K,T)

COMPRESSION FITTINGS

Compression fittings slip over tube of sensors for mounting and sealing into vessels.



TUBE O.D.	1/8"	3/16"	1/4"	MATERIAL
Thread Size	1/8-27 NPT	1/8-27 NPT	1/4-18 NPT	-----
Part No.	BT18-B	BT316-B	BT14-B	Brass
Part No.	BT18-S	BT316-S	BT-14-S	Stainless Steel

WEATHER-PROOF BOOT FOR STANDARD PLUGS & JACKS



2 - Required

#H420

LUNAR-PAK MINERAL INSULATED (BENDABLE) T/C'S

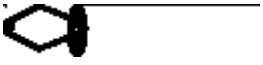
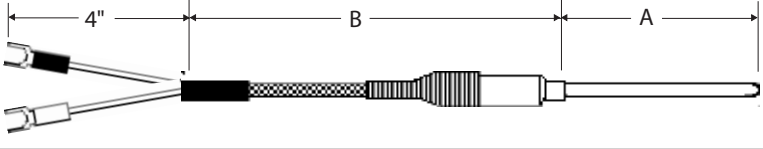
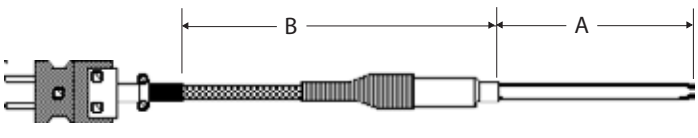
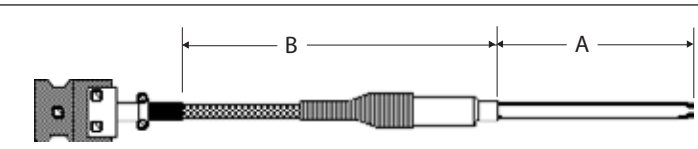
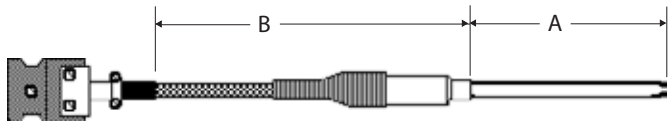
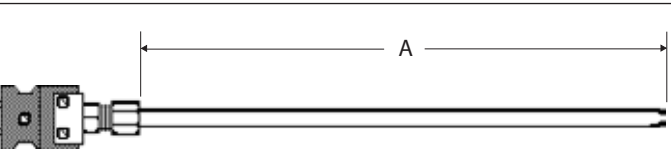
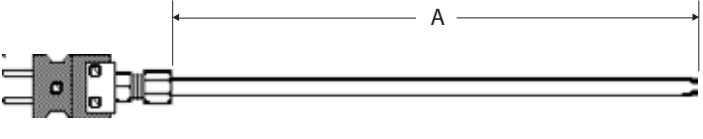
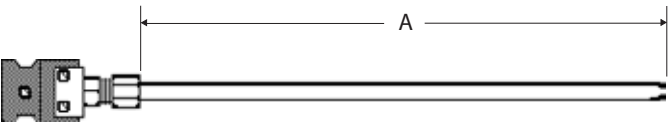
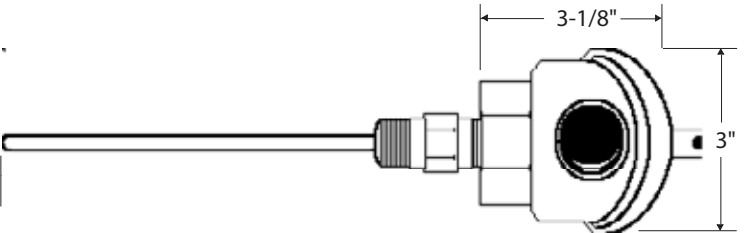
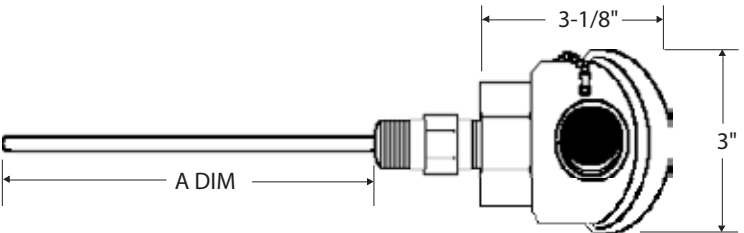
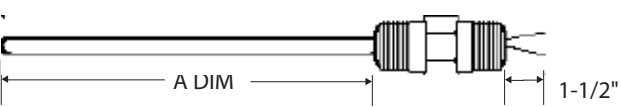
HOT JUNCTION TYPES	Grounded (G)	Ungrounded (UG)	Exposed (E)
FIG. 1	Thermocouple w/20 ga. fiberglass insulated lead wire.		
FIG. 2	Thermocouple w/20 ga. fiberglass insulated lead wire and stainless steel overbraid.		
FIG. 3	Thermocouple w/20 ga. fiberglass lead wire and terminated with male plug.		
FIG. 4	Thermocouple w/20 ga. fiberglass insulated lead wire and stainless steel overbraid and terminated with male plug.		
FIG. 5	Thermocouple w/20 ga. fiberglass insulated lead wire and terminated with female jack.		
FIG. 6	Thermocouple w/20 ga. fiberglass insulated lead wire and stainless steel overbraid and terminated with female jack.		
FIG. 7	Thermocouple terminated with male plug.		
FIG. 8	Thermocouple terminated with female jack.		
FIG. 9	Thermocouple terminated with hinged flip top cover weatherproof head and 1/2" x 1/2" NPT x 1-1/2" long 316 SS NPT mounting fitting brazed to sheath. For spring loading add "SL" to end of part number. Spring loaded type is not sealed from process and is generally used with a thermowell.		
NOTE: Screw cover head design is available at same price but must be requested otherwise flip top head will be supplied.			
FIG. 9-EP	Thermocouple terminated with explosion proof head - Same description as above except with screw cover explosion proof head assembly.		
FIG. 10-NPT	Replacement thermocouple element for figures 9 through 9-EP. Sheath is silver soldered to 1/2" NPT 316 SS MTG Nut.		

PLATINUM RESISTANCE TEMPERATURE DETECTOR (RTD) PROBES

FLIP TOP HEAD TYPE

Catalog Number	Alpha	Max Sheath Temp.
R288-1	0.00385	500°F
R288-1-HT	0.00385	1000°F
R388-1	0.00392	500°F
R388-1-HT	0.00392	1000°F

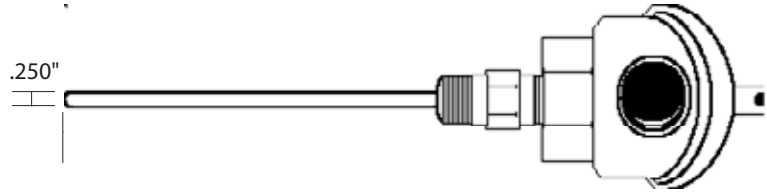

RTD terminated with hinged flip top cover weatherproof head and 1/2" x 1/2" NPT x 1-1/2" long 303 S. S. NPT mounting fitting brazed to sheath.

NOTE: For spring loading add "SL" to end of part number. Spring loaded type is not sealed from process. For adjustable immersion depth use compression fittings on page 8.

Screw cover head design is available at same price but must

HOW TO ORDER:

1. Specify catalog number.
2. Specify "A" length.
3. Specify 2, 3 or 4 wires

Order Example: R288-1 A=4" 3 wires

GENERAL PURPOSE TYPE

Catalog Number	Alpha	Lead Type	Max Sheath Temp.
R218-38	0.00385	teflon	400°F
R218-38-HT	0.00385	teflon	1000°F
R318-38	0.00392	teflon	400°F
R318-38-HT	0.00392	teflon	1000°F

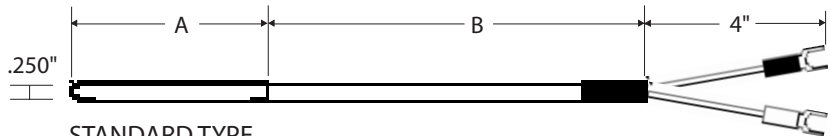

STANDARD TYPE

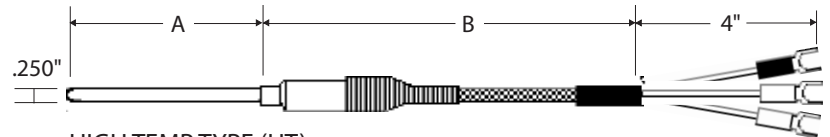

HIGH TEMP TYPE (HT) with Transition & Strain Relief Spring

NOTES:

1. For adjustable immersion depth use compression fittings on page 8.
2. 304 Stainless steel tip with fiberglass or teflon covered wires.
3. Teflon wire rated 400°F. (Fiberglass lead wire available by request - rated 800°F)

HOW TO ORDER:

1. Specify catalog number.
2. Specify "A" length.
3. Specify "B" length.
4. Specify 2, 3 or 4 wires

Order Example: R218-38 A=4" B=5' 3 wires

TRANSITION FITTING DIMENSIONS

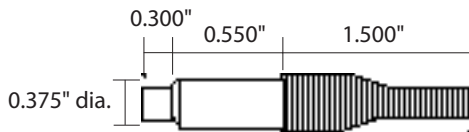

GENERAL SPECIFICATIONS

Type of Element: Platinum, 100 ohms @ 0°C ± 0.1 ohms. Calibration: DIN (European) curve. Alpha = .00385 ohms/ohm/°C or N.B.S. (American) curve. Alpha = .00392 ohms/ohm/°C. Leads: 22 ga. stranded unless otherwise specified.

RTD LEAD WIRE

Catalog Number	Gauge	Wire Type	Calibration	Insulation Each Conductor	Insulation Overall	Nominal Size O. D.
RT3-22-4-701	22	Stranded	RTD	PVC	PVC	.158
RT3-24-8-702	24	Stranded	RTD	Teflon/Fiberglass	Teflon	.145
RT3-24-8-705	24	Stranded	RTD	Fiberglass	Fiberglass	.090

Portable Thermocouples for use with Hand Held Digital Thermometers

Available in Type J, K, or T Calibrations

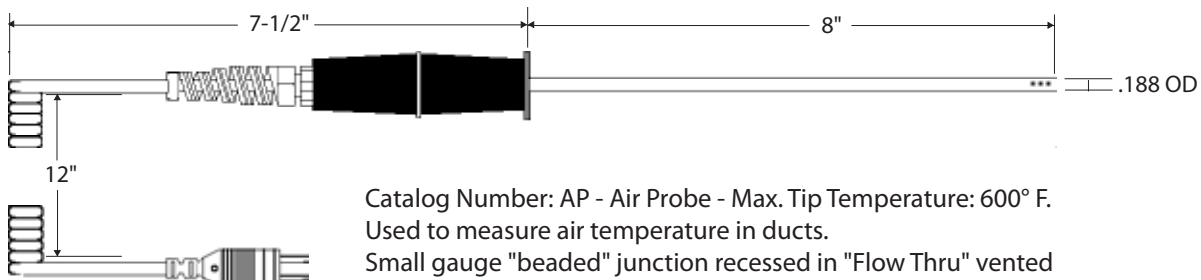
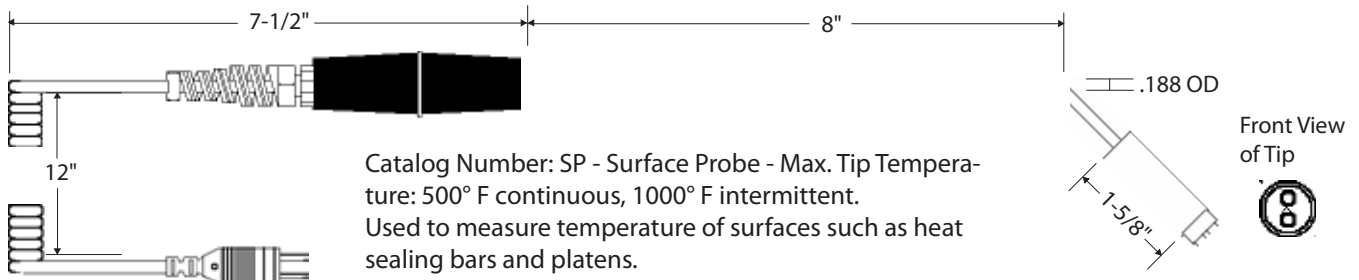
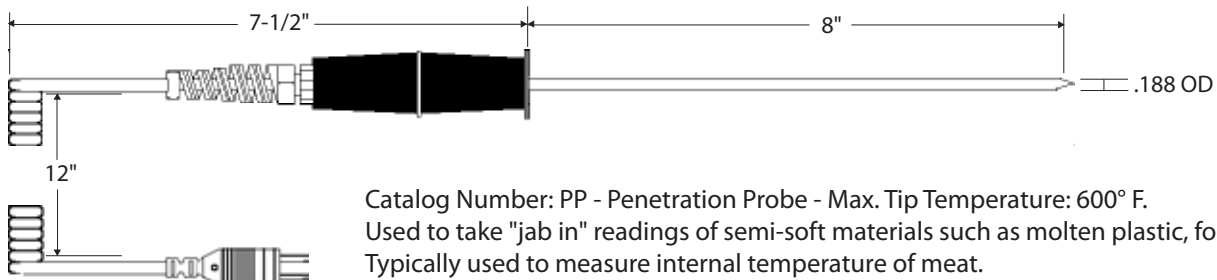
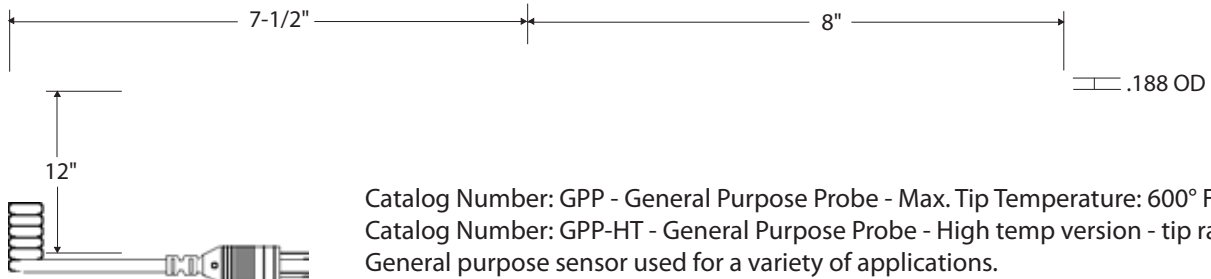

HOW TO ORDER:
 1. Specify catalog number
 2. Specify calibration
 Order Example: SP-K

NOTE: 1) Sheath (tip) available in other diameters, lengths and materials by request.
 2) Cable available in other lengths by request.
 3) A) Top collar is 303 SS. B) Handle is black phenolic. C) Strain relief is PVC.

PORTABLE THERMOMETERS

Jenco Model 701-J, K, T

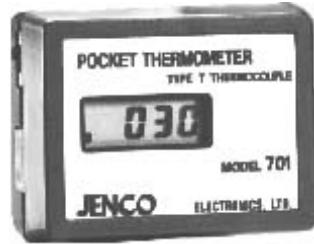

Jenco Model 7001H



Fluke Model 50 Series II



Extech Model TM100



Extech Model 421502



Extech Model 421509 Datalogger



Madgetech Model OctTemp2000



Extech Model 42515 Infrared

