

SELECTOR SWITCH

SERIES KR10 / KR15A

- DIN Size 48 (H) × 96 (W) mm
- Two Circuits & Six-Point Switching
- Push Button

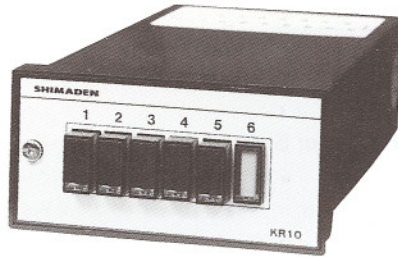

KR10

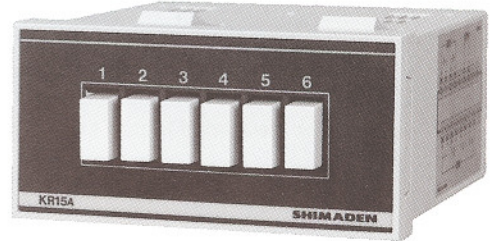

KR15A

SPECIFICATIONS

| | |
|--------------------------------------|---|
| No. of Switching Points: | 6 |
| No. of Switching Circuits: | 2 |
| Switching Operation Method: | Push button switching |
| Contact Rating: | |
| Voltage: | 30V max., AC / DC |
| Current: | 100mA max |
| Contact Resistance | 300mΩ (0.3Ω) max. / circuit |
| Switching Indication: | Push button indication |
| Operating Ambient Temperature Range: | -10~+50°C |
| Operating Ambient Humidity: | 90% RH max. |
| Installation: | Flush in panel |
| External Dimensions: | KR10 = 48 (H) × 96 (W) × 188 (D) mm KR15A = 48 (H) × 96 (W) × 118.5 (D) mm |
| Panel Cutout: | See next page. |
| Weight: | Approx. 330g (KR10) 300g (KR15A) |

ORDERING INFORMATION

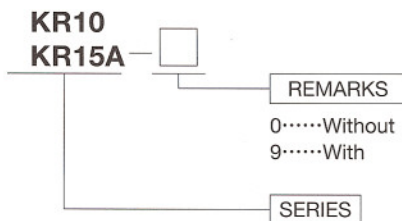

OPERATION EXAMPLES

Selection of Thermocouple (KR10, KR15A)

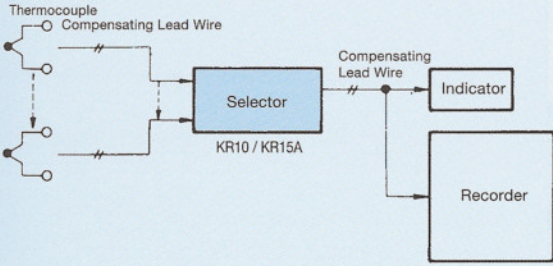

Selection of Voltage (KR10, KR15A)

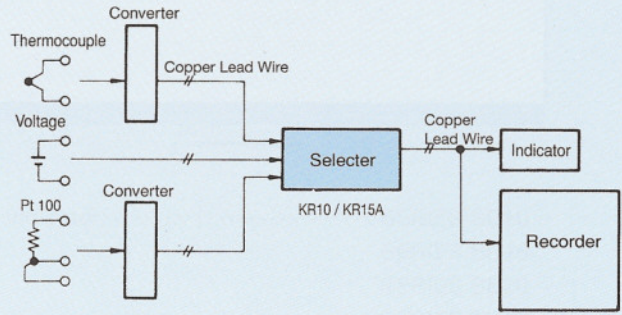

Selection of Transmissible Output (KR10, KR15A)

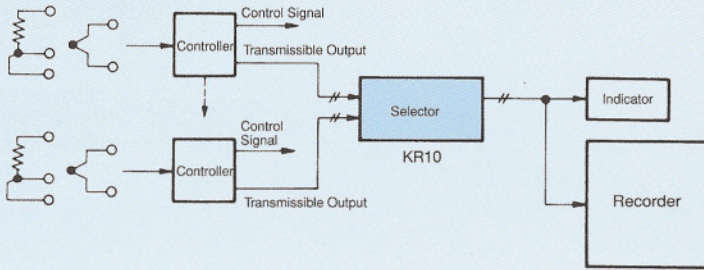

TERMINAL ARRANGEMENT

KR10

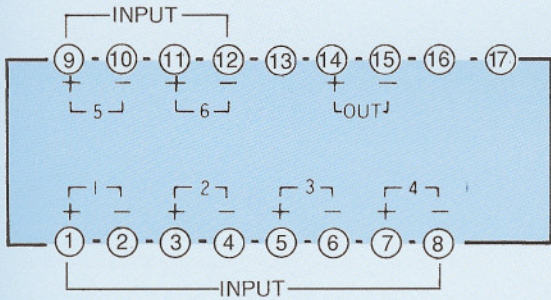

KR15A

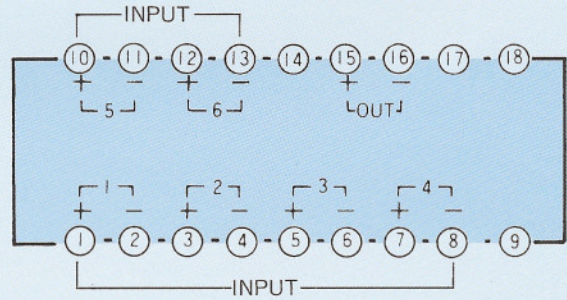

EXTERNAL DIMENSIONS & PANEL CUTOUT

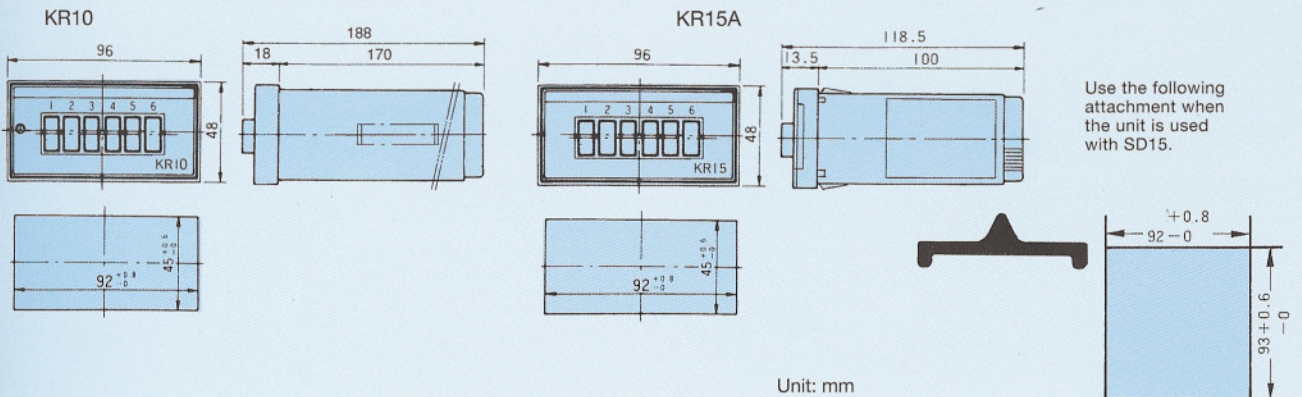

Unit: mm

Use the following attachment when the unit is used with SD15.